

User Manual

VER: B

Thank you for purchasing this product. We strongly recommend reading this user manual carefully before using, and keeping this user manual for future reference.

For Your Safety

Improper using of the Li-ion battery pack may cause heat, smoke, fire, or explosion. Please be sure to keep in mind the following precautions.

⚠ DANGER

- Charge with SWIT chargers only.
- Do not use battery in fire or hot places to prevent overheating, cracking and other hazards.
- Do not use battery beyond charge, discharge and storage environment temperature.
- Do not charge the battery in the car or in direct sunlight.
- Do not pierce the battery shell or try to open the shell and decompose the battery.
- Do not squeeze the battery shell which may cause physical damage.
- Do not use housing damaged battery.
- Keep the battery terminals clean and never short-circuit the battery terminals.
- Keep out of the reach of children.

⚠ WARNING

- Fully charged battery will discharge naturally and please use it as soon as it gets charged.
- The battery may become warm in use or while being charged. This is normal.
- Store the battery in cool and dry conditions.
- For long time storage, please keep the battery power above 50%.
- During long periods of inactivity, please remove the battery from the equipment.
- Do not use, store or place the battery in an electrostatic area.
- Make sure the input voltage, power consumption of the equipment to be powered meet the battery specifications.

Features

- ◆ 14.4V/28.8V Bi-voltage auto switch
- ◆ Compatible with normal voltage devices of 11-16.8V input
- ◆ Compatible with high voltage devices of 22-33.6V input
- ◆ Compatible with normal voltage chargers of 16.8V output
- ◆ 260Wh capacity, Max 400W constant high load
- ◆ 6A fast charging support by using SWIT fast charging charger
- ◆ 8-LED remaining time indicators
- ◆ Normal V-mount connection
- ◆ Strong 1.5m drop-off proof
- ◆ Multiple circuit protections

Bi-voltage Switching

The battery can output 14.4V(11-16.8V) or 28.8V(22-33.6V) by internal circuit switching.

When the voltage indicator LED is OFF, the battery is in 11-16.8V system; When the voltage indicator LED is ON, the battery is in 22-33.6V system.

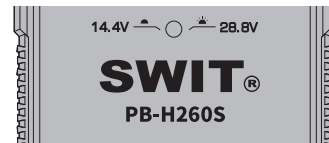

1. Working 14.4V (11-16.8V) Mode

In default condition, the Voltage indicator is "OFF", means the battery is 14.4V (11-16.8V) system, and can power normal 14.4V equipment and charge by normal 14.4V charger system.

2. Working 28.8V (22-33.6V) Mode

To active the 28.8V (22-33.6V) power output, there' re following 2 ways:
(1) By SWIT particular V-mount plates

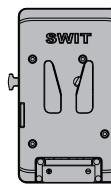
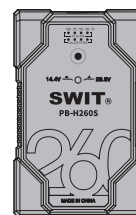

by KA-A20S V-mount Plate

- ◆ Fit for ARRI ALEXA / AMIRA
- ◆ Auto active 22-33.6V output of PB-H260S battery
- ◆ Provide D-tap and 2pin LEMO outputs of regulated 16V voltage

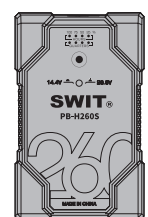
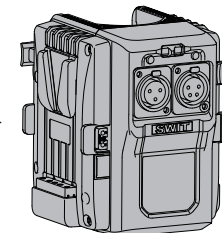

by TD-R210S 24V/48V Light Stand Adaptor

- ◆ 25-45mm light stand install
- ◆ Auto active 22-33.6V output of PB-H260S battery
- ◆ Output Max 48V 500W with 2x PB-H260S batteries

Product Appearance

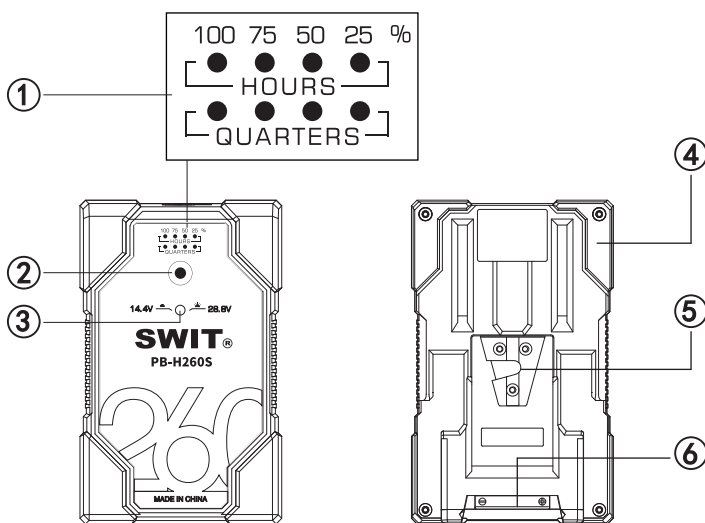

- ① LED power indicators
- ② Power check button
- ③ 14.4V/28.8V status indicator

- ④ Protective rubber covers
- ⑤ V-wedge
- ⑥ Power electrodes

2. Working 28.8V (22-33.6V) Mode (Continue)

(2) By SWIT “Magic Sticker” on 3rd party V-mount plates, for Cine Lights etc.

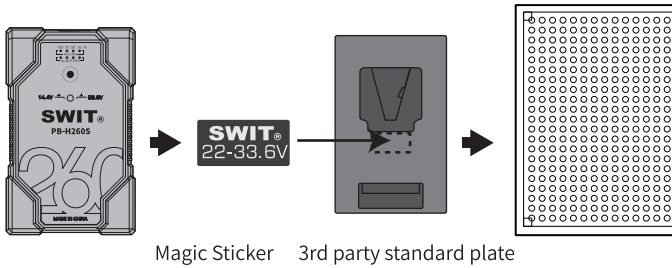

- ◆ Attach the Magic Sticker on the particular position of any standard 3rd party V-mount plates, and mount PB-H260S on, the PB-H260S will detect the Magic Sticker and automatically output 22-33.6V voltage.
- ◆ When PB-H260S battery outputs 22-33.6V, please mind the 3rd party V-mount plates D-tap socket (if they have) will output 22-33.6V voltage.

⚠ Caution

- ◆ Never attach the Magic Sticker to the battery directly!
- ◆ Make sure the Magic Sticker is firmly attached to the V-mount plate, will not fall off from the V-mount plate and will not adhere to the battery.
- ◆ Only attach the magic sticker to the battery mount plate of the equipment which can accept 22-33.6V high voltage input!
- ◆ Do not attach the Magic Sticker to the V-mount plate of chargers.
- ◆ With the magic sticker attached, the battery plate will output 22-33.6V high voltage from D-TAP socket (if it has). Always check the equipment to be powered from D-tap socket and make sure it can accept 22-33.6V voltage!
- ◆ If changing battery mount plate from the equipment, please remove the Magic Sticker to avoid misuse.

LED Power Indicators

The battery provides 8 LEDs to indicate remaining power percentage and remaining working time.

- ◆ When battery is discharging, press “Power Check” button, the light number of upper 4 LEDs indicate remaining working hours, and the light number of lower 4 LEDs indicate remaining working quarters, calculated by the current load.
- ◆ The LED will flash when remaining time is less than 15 minutes to remind changing battery.
- ◆ When battery is charging, the upper 4 LEDs flash constantly, indicates the capacity percentage 25%, 50%, 75% and 100%.
- ◆ When battery is free, press “Power Check” button, the upper 4 LEDs will light up, to indicate the remaining capacity percentage 25%, 50%, 75% and 100%.

In charging or free

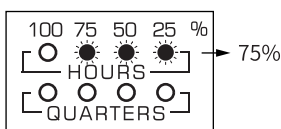

75% capacity remains
(LEDs display red)

In discharging

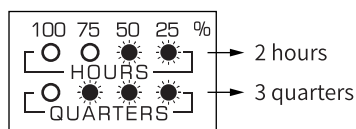

2h45min working time remains
(LEDs display green)

Charging

- ◆ Charge with SWIT chargers only.
- ◆ Max charging current is 6A.
- ◆ The battery should be charged under temperature range of 0-40°C however 10-30°C is recommended for optimizing the charging performance.
- ◆ Fully charged battery will discharge naturally and please use it as soon as it gets charged.

Discharging

- ◆ The battery has 11-16.8V or 22-33.6V bi-voltage output, please refer to the “Bi-voltage switching” chapter.
- ◆ The battery pack should discharge under temperature range of -20°C -50°C, however -10-40°C is recommended for a better performance.
- ◆ Make sure the total power consumption should not exceed battery max output power, otherwise the internal protection circuit will activate and cut off power to protect the battery cells.
- ◆ At low temperature, the battery internal resistance will increase, and will shorten the discharging time.

Multiple Circuit Protections

The battery has an MCU to measure and record the real time data, and will cut off power when over-voltage, under-voltage, over-load, high-temperature or low-temperature is detected.

- ◆ For over-load protection, please remove the battery from equipment and it will automatically recover after 1 minute standing.
- ◆ For overheat protection, place it in a cool place and the battery will automatically recover after cooling.
- ◆ For under-voltage protection after a long time not using, please charge the battery in time, and the battery will recover by itself.
- ◆ For over-voltage protection, please discharge the battery to reduce the voltage, and the battery will recover by itself.

Life Cycle

- ◆ The battery life may vary depending on frequency of use, storage and operation temperature environment.
- ◆ The battery life will be reduced if frequently used with full load applications.
- ◆ The battery life is also reduced if stored in fully charged and/or empty conditions for extended periods.

Specifications

Discharging mode	11-16.8V	22-33.6V
Nominal voltage	14.4V	28.8V
Capacity	260Wh, 18Ah	260Wh, 9Ah
Max Load	250W, 20A	400W, 16A
Cell chemistry	Li-ion	
Max charging current	16.8V/10A	
Environment	Charging	0~40°C (10-30°C recommended)
	Discharging	-20~50°C (-10-40°C recommended)
	Storage	-20~50°C
Dimension	162 × 101 × 69mm	
Net weight	1.5Kg	

SWIT Electronics Co., Ltd.

10 Hengtong Road, Nanjing 210038, P.R.China. Tel: +86-25-85805753

SWIT Electronics America Inc

3350 Scott Boulevard 61-02, Santa Clara, CA 95054, USA. Tel: (408)260-8258